

HITACHI

Liquid Crystal Projector

CP-S225W / CP-X275W

USER'S MANUAL

Please read this user's manual thoroughly to ensure correct usage through understanding.

BEDIENUNGSANLEITUNG

Bitte lesen Sie diese Bedienungsanleitung zugunsten der korrekten Bedienung aufmerksam.

MANUEL D'UTILISATION

Nous vous recommandons de lire attentivement ce manuel pour bien assimiler le fonctionnement de l'appareil.

MANUALE D'ISTRUZIONI

Vi preghiamo voler leggere attentamente il manuale d'istruzioni in modo tale da poter comprendere quanto riportato ai fini di un corretto utilizzo del proiettore.

MANUAL DE USUARIO

Lea cuidadosamente este manual del usuario para poder utilizar correctamente el producto.

GEBRUIKSAANWIJZING

Lees voor het gebruik alstublieft deze handleiding aandachtig door, om volledig profijt te hebben van de uitgebreide mogelijkheden.

BRUKERHÅNDBOK

Vennligst les denne bruksanvisningen grundig for å være garantert driftssikker bruk.

INSTRUÇÕES DO PROPRIETÁRIO

Para assegurar o uso correto do equipamento, por favor leia atentamente este manual do usuário.

TECHNICAL

REGULATORY NOTICES

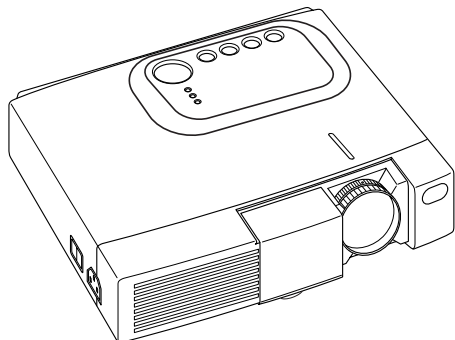

ENGLISH

DEUTSCH

FRANÇAIS

ITALIANO

ESPAÑOL

NEDERLANDS

NORSK

PORTUGÊS

TECHNICAL

USER'S MANUAL

Thank you for purchasing this liquid crystal projector.

WARNING • Please read the accompanying manual "SAFETY INSTRUCTIONS" and this "USER'S MANUAL" thoroughly to ensure correct usage through understanding. After reading, store this instruction manual in a safe place for future reference.

- NOTE** • The information in this manual is subject to change without notice.
- The manufacturer assumes no responsibility for any errors that may appear in this manual
 - The reproduction, transmission or use of this document or contents is not permitted without express written authority.

TRADEMARK ACKNOWLEDGMENT : PS/2, VGA and XGA are registered trademarks of International Business Machines Corporation. Apple, Mac and ADB are registered trademarks of Apple Computer, Inc. VESA and SVGA are trademarks of the Video Electronics Standard Association. Windows is a registered trademark of Microsoft Corporation. Carefully observe the trademarks and registered trademarks of all companies, even when not mentioned.

CONTENTS

	Page		Page
FEATURES	2	TROUBLESHOOTING	19
BEFORE USE	2	OSD Message	19
Contents of Package	2	Indicators Message	20
Part Names.....	3	Symptom	21
Loading the Battery	4	SPECIFICATIONS	22
INSTALLATION	5	WARRANTY AND AFTER-SERVICE	23
Installation of the Projector and Screen.....	5	
Angle Adjustment	5	TABLES	
Cabling	6	Table 1. Installation Reference.....	5
Power Connection	7	Table 2. Cabling	6
Example of System Setup	7	Table 3. Basic Operations	9
Plug & Play	7	Table 4. Setup Menu	11
OPERATIONS	8	Table 5. Input Menu.....	12
Power ON	8	Table 6. Image Menu.....	13
Power OFF	8	Table 7. Options Menu	14
Basic Operation.....	9	Table 8. No Signal Menu.....	15
Setup Menu	11	Table 9. OSD Message	19
Input Menu.....	12	Table 10. Indicator Message	20
Image Menu.....	13	Table 11. Symptom	21
Options Menu	14	Table 12. Specifications	22
No Signal Menu	15	
MAINTENANCE	16	For "TECHNICAL" and "REGULATORY NOTICE", see the end of this manual.	
Lamp.....	16		
Air Filter	18		
Other Maintenance	18		

FEATURES

This liquid crystal projector is used to project various computer signals as well as NTSC / PAL / SECAM video signals onto a screen. Little space is required for installation and large images can easily be realized.

Outstanding Brightness

The UHB lamp and high-efficiency optical system assure a high level of brightness.

Partial Magnification Function

Interesting parts of images can be magnified for closer viewing.

Distortion Correction Function

Distortion-free images are quickly available.

Extra-low Noise Function

Acoustic noise level from the unit can be reduced.

BEFORE USE

Contents of package

Make sure all of the following items are included in the package. If anything is missing, please contact your dealer.

NOTE • Keep the original packing material for future reshipment.

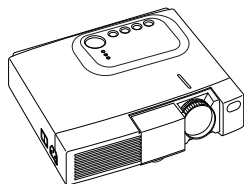

Projector



Power Cord
(US Type)



Power Cord
(UK Type)



Power Cord
(Europe Type)



User's Manual
(this manual)

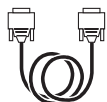

RGB Cable



Component
Video Cable
(with green lead)



Safety Instructions

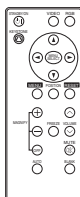

Remote Controller
containing Battery

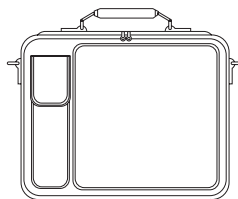

Carrying Bag

BEFORE USE (continued)

Part Names

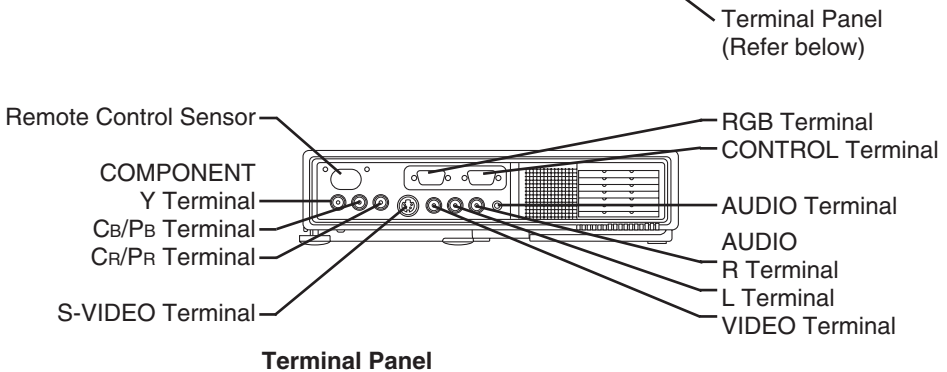
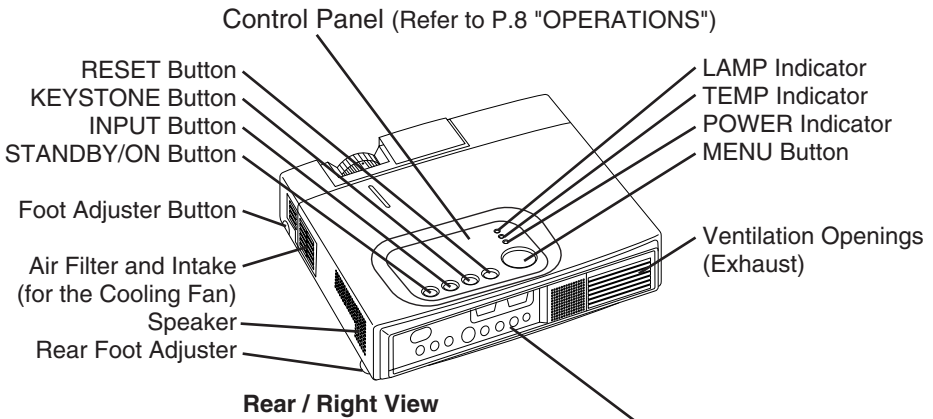
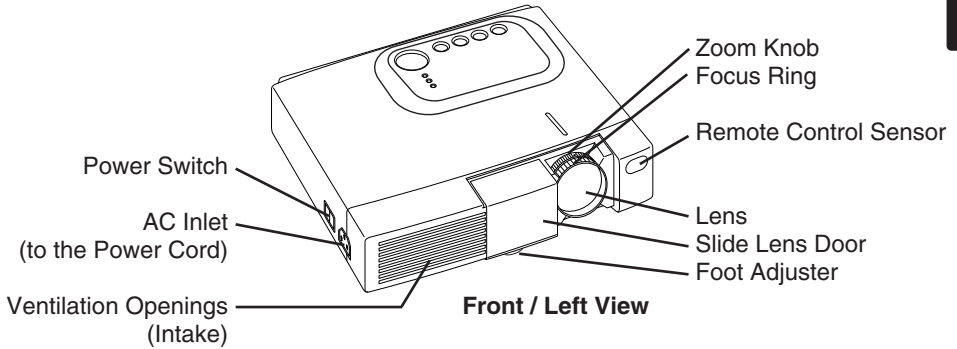

BEFORE USE (continued)

Part Names (continued)

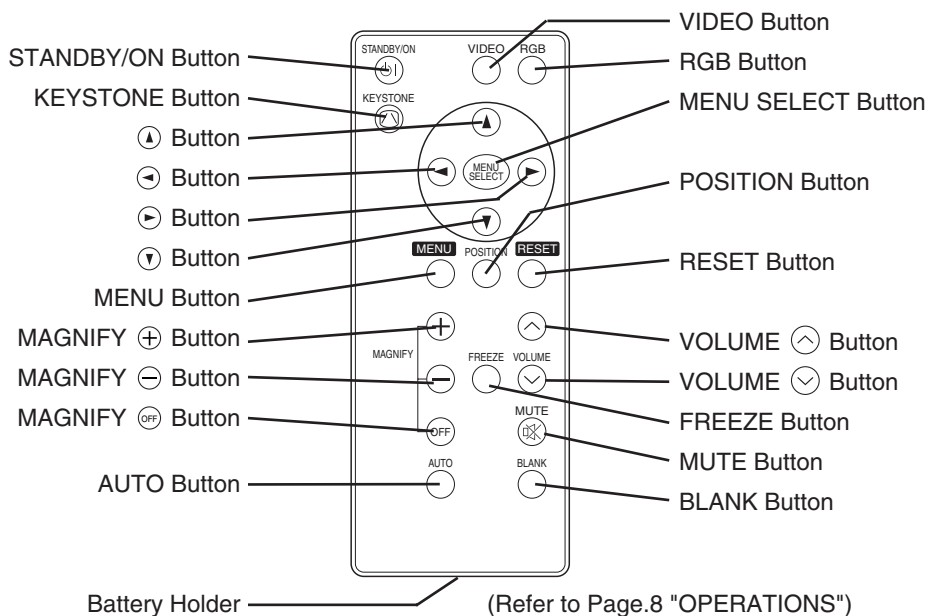

Remote Controller

Loading the Batteries

First Loading:

In original packing, the battery is installed in the battery holder of the remote controller with protection film(the transparent film some of which is inside the battery folder). Pull out the protection film to load the battery.

Replacing:

1. See the reverse side of the remote controller.
2. Pinch the groove and pull out battery holder as the drawing right.
3. Remove the worn battery.
4. Install the new battery with "+" side facing.
5. Push in and click the battery holder.

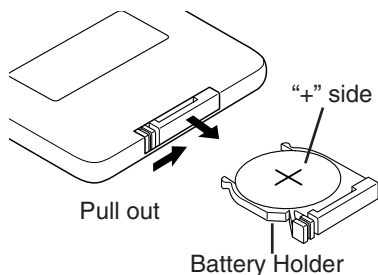

CAUTION • Incorrect handling of the battery could result in fire or personal injury. The battery may explode if not handled properly. Be careful in handling the battery according to instructions of accompanying manual "SAFETY INSTRUCTIONS" and this manual.

- Use the 3V micro lithium battery type no.CR2025 only.
- When loading the battery, make sure the plus and minus terminals are correctly oriented as indicated in the remote controller.
- When you dispose the battery, you should obey the law in the relative area or country.
- Keep the battery away from children and pets.
- When not to be used for an extended period, remove the battery from the remote controller.

NOTE Replace the batteries when remote control transmitter operation becomes difficult.

INSTALLATION

Installation of the Projector and Screen

Refer to the drawing and table below for determining the screen size and projection distance.

The projection distances shown in the table below are for full size (CP-S225W:800 x 600 dots / CP-X275W:1024 x 768 dots).

- a: Distance from the projector to the screen. ($\pm 10\%$)
- b: Distance from the lens center to the bottom of the screen. ($\pm 10\%$)

Table 1. Installation Reference

Screen size [inches (m)]	a [inches (m)]		b [inches (cm)]
	Min.	Max.	
40 (1.0)	37 (0.9)	46 (1.2)	3 (8.7)
60 (1.5)	57 (1.5)	69 (1.8)	5 (13.1)
80 (2.0)	77 (1.9)	93 (2.4)	7 (17.4)
100 (2.5)	96 (2.4)	116 (2.9)	9 (21.8)
120 (3.0)	116 (2.9)	139 (3.5)	10 (26.1)
150 (3.8)	145 (3.7)	174 (4.4)	13 (32.7)
200 (5.0)	194 (4.9)	233 (5.9)	17 (43.5)

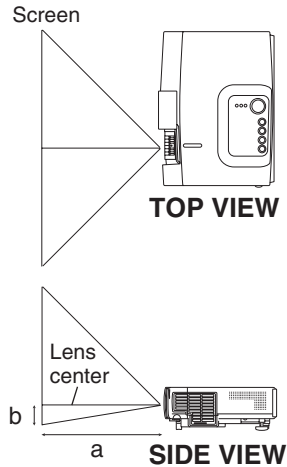

CAUTION • Install the projector in a suitable environment according to instructions of the accompanying manual “SAFETY INSTRUCTIONS” and this manual.

- Please basically use liquid crystal projector at the horizontal position. If you use liquid crystal projector by the lens up position, the lens down position and the side up position, this may cause the heat inside to build up and cause damage. Be especially careful not to install it with ventilation holes blocked.
- Do not install LCD projector in smoke effected environment. Smoke residue may buildup on critical parts (i.e.LCD panel, Lens Assy etc.).

Angle Adjustment

Use the foot adjusters on the bottom of the projector to adjust the projection angle. It is variable within 0° to 10° approximately.

1. Lift up the front side of the projector, and pressing the foot adjuster button, adjust the projection angle.
2. Release the button to lock at the desired angle.
3. Make the rear foot adjuster screw to adjust the left-right slope.

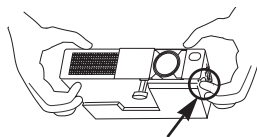
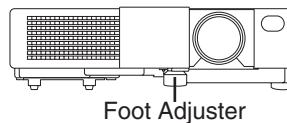

Press the foot adjuster button

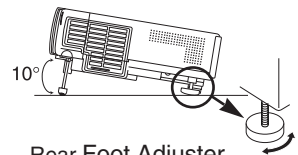

Rear Foot Adjuster

CAUTION • Do not release the foot adjuster button unless the projector is being held; otherwise, the projector could overturn or fingers could get caught and cause personal injury.

INSTALLATION (continued)

Cabling

Refer to the table below for connecting each terminal of the projector to a device.

Table 2. Cabling

Function	Terminal	Cable
Analog RGB input	RGB	Accessory RGB cable or optional RGB cable with D-sub 15-pin shrink jack and inch thread screws
RS-232C communication	CONTROL	Optional RS-232C cable
Audio input (from the computer)	AUDIO	Optional audio cable with stereo mini jack
Component video input	COMPONENT VIDEO Y	Accessory component video cable
	COMPONENT VIDEO Cb/Pb	
	COMPONENT VIDEO Cr/Pr	
S-video input	S-VIDEO	Optional S-video cable with mini DIN 4-pin jack
Video input	VIDEO	Optional video/audio cable with RCA jack
Audio input (from video equipment)	AUDIO L	
	AUDIO R	



CAUTION • Incorrect connecting could result in fire or electrical shock.

Please read this manual and the separate “SAFETY INSTRUCTIONS”.

- Before connecting, turn off to all devices to be connected, except for the USB cable.
- The cables may have to be used with the core set to the projector side. Use the cables which are included with the projector or specified.

NOTE • Before connecting, read instruction manuals of the devices to be connected, and make sure that the projector is compatible with the device.

- Secure the screws on the connectors and tighten.
- For some RGB input modes, the optional Mac adapter is necessary.
- To select the digital RGB input, the computer may need some settings. See the manuals of the computer for details.
- Some computers may have multiple display screen modes. Use of some of these modes will not be possible with this projector.
- Refer to the “TECHNICAL” section for the pin assignment of connectors.
- Refer to manual of the optional RS-232C cable, for the communication data.
- For others, consult your dealer.

INSTALLATION (continued)

Power Connection

Use the correct power cord depending on the power outlet to be used.

Connect the AC inlet of the projector to the power outlet firmly by the power cord.

- CAUTION** • Be careful in handling the power cord according to instructions of the accompanying manual "SAFETY INSTRUCTIONS" and this manual.
- Connect the power cord firmly. Avoid using a loose, unsound outlet or failed contact.

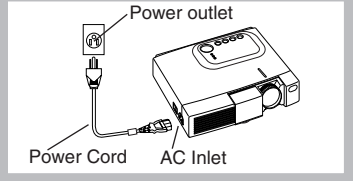

Example of system setup

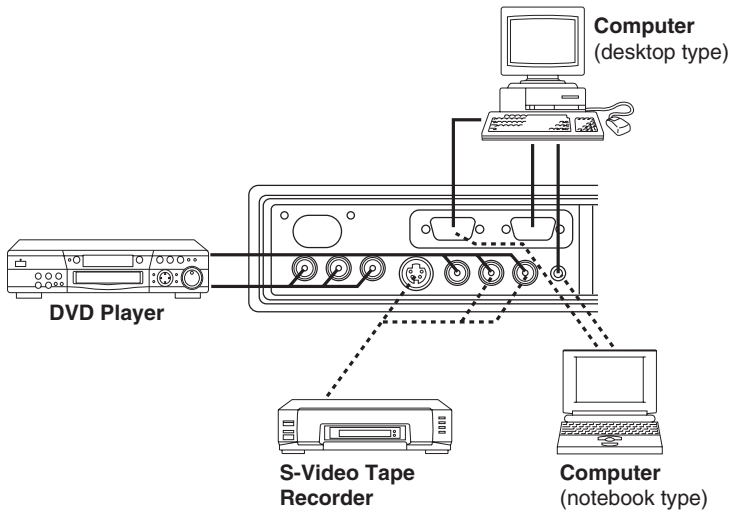

NOTE • When connecting with a notebook computer, set the proper RGB external image output (setting CRT display or simultaneous display of LCD and CRT). Please read instruction manual of the notebook for more information.

Plug & Play

This projector is VESA DDC 1/2B compatible. Plug & play is possible by connecting to a computer that is VESA DDC (Display Data Channel) compatible.

Please use this function by connecting the accessory RGB cable with RGB terminal. Plug & play may not operate by other connections.

NOTE • Plug & play is a system configured with peripheral equipment including a computer, display and an operating system.

- This projector is recognized as a plug & play monitor. Use the standard display drivers.
- Plug & play may not operate by the computer to connect.

OPERATIONS

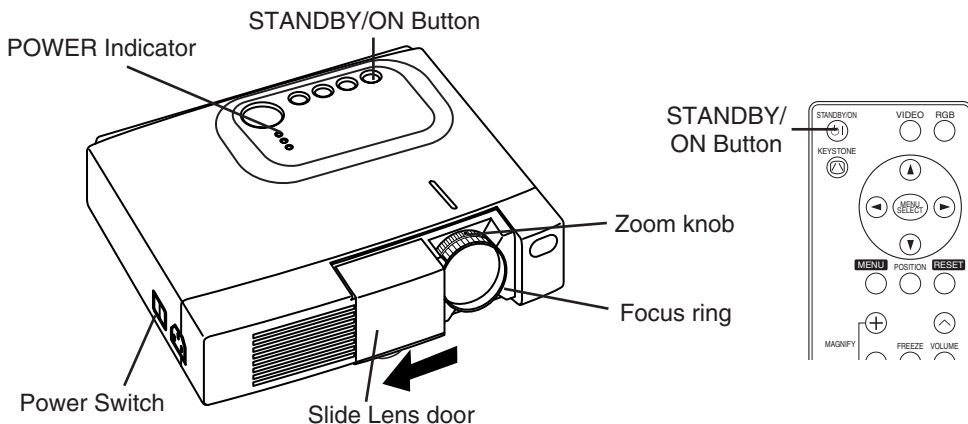

Power ON

1. Check that the power cord is connected correctly.
2. Set the power switch to [I]. The standby mode is selected, and the POWER indicator is turned to orange.
3. Press the STANDBY/ON button (Ⓛ) on the control panel or the remote controller. Warm-up begins and the POWER indicator blinks in green.
4. The POWER indicator ceases blinking and turns to green when power is on. Open the slide lens door.
5. Adjust picture size using the Zoom knob.
6. Adjust focus using the Focus ring.

Power OFF

1. Press the STANDBY/ON button (Ⓛ) on the control panel or the remote controller. Then, the message "Power off?" will appear on the screen, and the message will disappear by any operation or no operation for 5 seconds. During this message indication, press the STANDBY/ON (Ⓛ) button again. The projector lamp is extinguished and lamp cooling begins. The POWER indicator blinks orange during lamp cooling. Pressing the STANDBY/ON (Ⓛ) has no effect while the POWER indicator is blinking.
2. The system assumes the Standby mode when cooling is complete, and the POWER indicator ceases blinking and changes to orange. Check that the indicator is orange and set the Power switch to [O].
3. The POWER indicator is extinguished when power is off. Do not forget to close the lens door.



WARNING • Please read this manual, and the separate "SAFETY INSTRUCTIONS" thoroughly before using the equipment. Always ensure that the equipment is used safely.

NOTE • Except in emergencies, do not turn off unless the POWER indicator is orange as it will reduce the life of the projector lamp.

- To prevent any trouble, turn on/off the projector when the computer or video tape recorder is OFF. Providing a RS-232C cable is connected, turn on the computer before the projector.
- When a projector continues projecting the same image, the image may remain as an afterimage. Please do not project the image same for a long time.

OPERATIONS (continued)

Basic Operation

The basic operations shown in Table 3 is performed from the supplied remote controller or the projector control panel. Items indicated by (*) may be used from the control panel.

Table 3 . Basic Operation

Item	Description
INPUT SELECT	<p>Select Input Signal (*) : Press the INPUT button. RGB → VIDEO → S-VIDEO → COMPONENT (→ RGB) Select RGB Input : Press the RGB button. VIDEO/S-VIDEO/COMPONENT → RGB Select Video Input : Press the VIDEO button. RGB → VIDEO/S-VIDEO/COMPONENT VIDEO → S-VIDEO → COMPONENT (→ VIDEO)</p> <ul style="list-style-type: none"> The selected signal name is displayed for approximately 3 seconds when the input signal is changed.
POSITION	<p>Set/Clear Position Adjustment Mode : Press the POSITION button. The [] icon is displayed in the POSITION mode. Image Position Adjustment: Press the ⬇️, ⬅️, ⬆️ and ⬇️ buttons in the POSITION mode.</p> <ul style="list-style-type: none"> Valid only in the MAGNIFY mode with a video signal is input. After approximately 10 seconds of inactivity the [] icon is extinguished and the POSITION mode is cleared automatically.
RESET (*)	<p>Initialize Each Item : Select an item and press the RESET button. Initialize Position Adjustment : Press the RESET button and the POSITION mode. This function is valid only when RGB signal is input.</p> <ul style="list-style-type: none"> Valid except for the VOLUME, LANGUAGE, H PHASE and WISPER.
MAGNIFY	<p>Set MAGNIFY Mode : Press the MAGNIFY ⊕ button. Move Magnified Area : Run the POSITION in the MAGNIFY mode. Adjust Magnification : Press the MAGNIFY ⊕ / ⊖ button in MAGNIFY mode. MAGNIFY ⊕ magnifies the image ↔ MAGNIFY ⊖ reduces the image Clear MAGNIFY Mode : Press the MAGNIFY ⊖ button.</p> <ul style="list-style-type: none"> The MAGNIFY mode is cleared by running or setting the AUTO, ASPECT, INPUT SELECT or VIDEO, or by changing the input signal.
FREEZE	<p>Set/Clear FREEZE Mode : Press the FREEZE button. The [] icon is displayed, and the image frozen, in the FREEZE mode.</p> <ul style="list-style-type: none"> The FREEZE mode is cleared by running or setting POSITION, VOLUME, MUTE, Automatic Adjustment, BLANK ON/OFF, or MENU ON/OFF, or by changing the input signal. Do not forget to clear frozen static images.
KEYSTONE (*)	<p>Set/Clear KEYSTONE Mode : Press the KEYSTONE Ⓜ️ button. Adjust Keystone : Press the ⬇️ / ⬆️ button in the KEYSTONE mode. ⬇️ reduces the bottom size of image ↔ ⬆️ reduces the top size of image</p>

NOTE • Use the remote controller at a distance of approximately 3m from the sensor on the front of the projector, and within a range of 30° left-right. Strong light and obstacles will interfere with operation of the remote controller.

(It continue the next page.)

OPERATIONS (continued)

Items indicated by (*) may be used from the control panel.

Table 3. Basic Operation (continued)

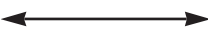
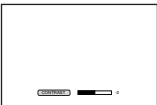
Item	Description
VOLUME	Volume Adjustment : Press the VOLUME ⏪ / ⏩ button. ⏪ reduces the volume ↔ ⏩ increases the volume
MUTE	Set/Clear Mute Mode : Press the MUTE button. No sound is heard in the MUTE mode.
AUTO	Automatic Adjustment at RGB Input : Press the AUTO button. Horizontal position(H.POSIT), vertical position (V.POSIT),clock phase (H.PHASE), and horizontal size(H.SIZE) are automatically adjusted. Use with the window at maximum size in the application display. Automatic Adjustment at Video Input : Press the AUTO button. A signal type appropriate for the input signal is selected automatically. Valid only when AUTO is set for VIDEO on the menu. • This operation requires approximately ten seconds. It may not function correctly with some input signals.
BLANK ON/OFF	Set/Clear Blank Mode: Press the BLANK button. No image is displayed in the Blank mode. The screen color is as set in BLANK on the Image menu.
MENU ON/OFF (*)	Menu Display Start/Stop: Press the MENU button. • The menu display is terminated automatically after approximately ten seconds of inactivity.
MENU SELECT	Select Menu Type: Press the MENU SELECT button. Allows the user to select the normal menu or the single menu. Only the selected item is displayed on the single menu, and other items are displayed with the ⏪ and ⏩ buttons as with the normal menu. • Valid only when the Setup menu is used. Push the MENU SELECT button after selecting items such as "BRIGHTNESS". <div style="display: flex; justify-content: space-around; align-items: center;"> <div style="text-align: center;"> <p>Normal menu</p>  </div> <div style="text-align: center;"> <p>(MENU SELECT)</p>  </div> <div style="text-align: center;"> <p>Single menu</p>  </div> </div>

OPERATIONS (continued)

Setup Menu

The following adjustments and settings are possible when SETUP is selected at the top of the menu. Part of the Setup menu differs between RGB input and video input. Select an item with the \odot and \ominus buttons, and start operation. Use the Single menu to reduce menu size (see Table 3, MENU SELECT).

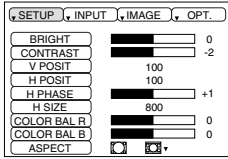

RGB

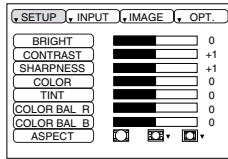

VIDEO/S-VIDEO

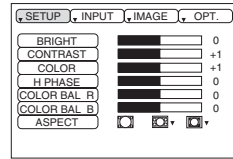

COMPONENT

Table 4. Setup Menu

Item	Description	RGB	VIDEO S-VIDEO	COMPONENT	
				480i 575i 480P	720P 1080i
BRIGHT	Dark \ominus \leftrightarrow Light \oplus	✓	✓	✓	✓
CONTRAST	Weak \ominus \leftrightarrow Strong \oplus	✓	✓	✓	✓
V POSIT	Down \ominus \leftrightarrow Up \oplus	✓	-	-	-
H POSIT	Left \ominus \leftrightarrow Right \oplus	✓	-	-	-
H PHASE	Left \ominus \leftrightarrow Right \oplus • Adjust to eliminate flicker.	✓	-	✓	✓
H SIZE	Small \ominus \leftrightarrow Large \oplus • The image may not be displayed correctly if the horizontal size is excessive. In such cases, press the RESET button, and initialize the horizontal size.	✓	-	-	-
SHARPNESS	Soft \ominus \leftrightarrow Clear \oplus	-	✓	-	-
COLOR	Light \ominus \leftrightarrow Dark \oplus	-	✓	✓	✓
TINT	Red \ominus \leftrightarrow Green \oplus • Valid only when NTSC or NTSC 4.43 signal is received.	-	✓	-	-
COLOR BAL R	Light \ominus \leftrightarrow Dark \oplus	✓	✓	✓	✓
COLOR BAL B	Light \ominus \leftrightarrow Dark \oplus	✓	✓	✓	✓
ASPECT	Select Image Aspect Ratio : 4:3 [] \ominus \leftrightarrow \oplus 16:9 [] Select Position of Image: Press the \ominus button while 16:9 [] is selected. Center \rightarrow \ominus Down \rightarrow \oplus Up (\rightarrow Center \oplus)	✓	-	-	✓
	Select Image Aspect Ratio: 4:3 [] \ominus \leftrightarrow \oplus 16:9 [] \ominus \leftrightarrow \oplus 4:3 small [] Select Position of Image : Press the \ominus button while 16:9 [] / 4:3 small [] is selected. Center \rightarrow \ominus Down \rightarrow \oplus Up (\rightarrow Center \oplus) • 4:3 small may not be displayed correctly with some input signals.	-	✓	✓	-

OPERATIONS (continued)

Input Menu

The following functions are available when INPUT is selected on the menu. Select an item with the \blacktriangle and \blacktriangledown buttons, and start operation.

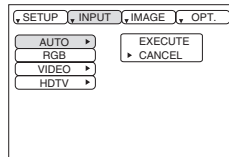

Table 5. Input Menu

Item	Description
AUTO	<p>Operation Start/Stop: Press the \blacktriangle / \blacktriangledown button.</p> <p>Automatic Adjustment at RGB Input: Select the EXECUTE with the \blacktriangle button. Horizontal position (H.POSIT), vertical position (V.POSIT), clock phase (H.PHASE), and horizontal size (H.SIZE) are automatically adjusted. Use with the window at maximum size in the application display.</p> <ul style="list-style-type: none"> • This operation requires approximately 10 seconds. It may not function correctly with some input signals. Pressing the AUTO button in this case may correct this problem. • This function is the same as for the AUTO function in Basic operation.
RGB	<p>Displays RGB Input Frequency:</p> <p>Displays the horizontal and vertical sync signal frequencies for RGB input.</p> <ul style="list-style-type: none"> • Valid only at RGB input.
VIDEO	<p>Operation Start/Stop: Press the \blacktriangle / \blacktriangledown button.</p> <p>Select Video Signal Type: Select the signal type with the \blacktriangle and \blacktriangledown buttons. Select NTSC, PAL, SECAM, NTSC4.43, M-PAL, or N-PAL as appropriate for the input signal. The selection of AUTO enables and executes the function AUTO (Automatic Adjustment at Video Input), except for the N-PAL input.</p> <ul style="list-style-type: none"> • Use this function when the image becomes unstable (eg. the image becomes irregular, or lacks color) at VIDEO/S-VIDEO input. • Automatic Adjustment requires approximately ten seconds. It may not function correctly with some input signals. Pressing the AUTO button in this case may correct this problem except for the N-PAL input. • For the COMPONENT VIDEO input, this function is not effective and the signal type is distinguished automatically.
HDTV	<p>Operation Start/Stop: Press the \blacktriangle / \blacktriangledown button.</p> <p>Select HDTV Mode: Select the 1080i mode or 1035i mode suitable for the input signal with the \blacktriangle / \blacktriangledown button.</p> <ul style="list-style-type: none"> • When the selected HDTV mode is incompatible with the input signal, the image may be incorrect (eg. the display position or color is incorrect).

OPERATIONS (continued)

Image Menu

The following adjustments and settings are available when IMAGE is selected on the menu. Select an item with the \uparrow and \downarrow buttons, and start operation.

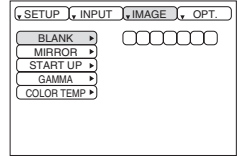

Table 6. Image Menu

Item	Description
BLANK	<p>Select Blank Screen Color: Select color with the \ominus and \oplus buttons.</p> <p>•The image is cleared and the entire screen is displayed in the selected color, when BLANK mode is set with BLANK ON, or when there is no signal for 5 minutes.</p>
MIRROR	<p>Operation Start/Stop: Press the \ominus / \oplus button.</p> <p>Select Mirror Status: Select mirror status with \uparrow and \downarrow buttons.</p>
START UP	<p>Operation Start/Stop: Press the \ominus / \oplus button.</p> <p>Setup Initial Screen Display: Select TURN ON with the \uparrow button.</p> <p>Clear Initial Screen Display: Select TURN OFF with the \downarrow button.</p> <p>• Note that if TURN OFF is selected the blank screen is displayed in blue when there is no signal.</p>
GAMMA	<p>Operation Start/Stop: Press the \ominus / \oplus button.</p> <p>Select Gamma Mode : Select the gamma mode with the \uparrow / \downarrow button.</p>
COLOR TEMP	<p>Operation Start/Stop: Press the \ominus / \oplus button.</p> <p>Select Color Temperature:</p> <p>Select the color temperature mode with the \uparrow / \downarrow button.</p>

OPERATIONS (continued)

Options Menu

The following adjustments and settings are available when OPT. is selected on the menu. Select an item with the ⬆ and ⬇ buttons, and start operation.

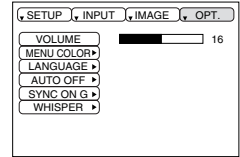

Table 7. Options Menu

Item	Description
VOLUME	Volume Adjustment: Reduce VOLUME ⬇ ↔ Increase VOLUME ⬆
MENU COLOR	Select Menu Background Color: Select with the ⬆ and ⬇ buttons.
LANGUAGE	Operation Start/Stop: Press the ⬆ or ⬇ button. Select Menu Display Language: Select with the ⬆ and ⬇ buttons.
AUTO OFF	Operation Start/Stop: Press the ⬆ or ⬇ button. Set AUTO OFF: Set 1~99 minutes with the ⬆ and ⬇ buttons. The system automatically enters the standby mode when a signal is not received for the set time. Clear AUTO OFF: Select STOP (0 min.) with the ⬇ button. When STOP is selected the system does not enter the standby mode even if no signal is received.
SYNC ON G	Operation Start/Stop: Press the ⬆ or ⬇ button. SYNC ON G Valid: Select TURN ON with the ⬆ button. SYNC ON G Invalid: Select TURN OFF with the ⬇ button. • May not be displayed correctly with some input signals when SYNC ON G is valid. In such cases, remove the signal connector so that no signal is received, set SYNC ON G to invalid, and reconnect the signal.
WHISPER	Operation Start/Stop: Press the ⬆ or ⬇ button. Set/Clear Wisper Mode: Press ⬆/⬇ button. When the WHISPER is selected, the WHISPER mode is active. In the WHISPER mode, acoustic noise level from the unit is reduced, brightness level on screen is a little lower.

OPERATIONS (continued)

No Signal Menu

The same adjustments and settings are available with the Image and Options menus when the MENU button is pressed during display of the “NO INPUT IS DETECTED ON ***” or “SYNC IS OUT OF RANGE ON ***” message while no signal is received.

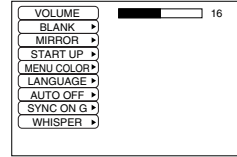

Table 8. No Signal Menu

Item	Description
VOLUME	<p>Volume Adjustment: Reduce VOLUME ◀ ↔ Increase VOLUME ▶</p> <ul style="list-style-type: none"> When this function is used, audio input is automatically switched to video. The audio input can be switched by moving the DISK PAD left and right during the display of the volume adjustment bar. The volume adjustment bar is displayed by pressing VOLUME ◀ or VOLUME ▶ button.
BLANK	<p>Select Blank Screen Color: Select the color with the ◀ and ▶ buttons.</p> <ul style="list-style-type: none"> The image is cleared and the entire screen is displayed in the selected color, when BLANK mode is set with BLANK ON, or when there is no signal for 5 minutes.
MIRROR	<p>Operation Start/Stop: Press the ◀ / ▶ button.</p> <p>Select Mirror Status: Select the mirror status with the ▲ and ▼ buttons.</p>
START UP	<p>Operation Start/Stop: Press the ◀ / ▶ button.</p> <p>Setup Initial Screen Display: Select the TURN ON with the ▲ button.</p> <p>Clear Initial Screen Display: Select the TURN OFF with the ▼ button.</p> <ul style="list-style-type: none"> Note that if TURN OFF is selected the blank screen is displayed in blue when there is no signal.
MENU COLOR	<p>Select Menu Background Color: Select the color with the ◀ and ▶ buttons.</p>
LANGUAGE	<p>Operation Start/Stop: Press the ◀ / ▶ button.</p> <p>Select Menu Display Language: Select the language with the ▲ and ▼ buttons.</p>
AUTO OFF	<p>Operation start/stop: Press the ◀ / ▶ button.</p> <p>Set AUTO OFF: Set 1~99 minutes with the ▲ and ▼ buttons. The system automatically enters the standby mode when a signal is not received for the set time.</p> <p>Clear AUTO OFF: Select the STOP (0 min.) with the ▼ button. When the STOP is selected the system does not enter the standby mode even if no signal is received.</p>
SYNC ON G	<p>Operation Start/Stop: Press the ◀ / ▶ button.</p> <p>SYNC ON G Valid: Select the TURN ON with the ▲ button.</p> <p>SYNC ON G Invalid: Select the TURN OFF with the ▼ button.</p> <ul style="list-style-type: none"> May not be displayed correctly with some input signals when the SYNC ON G is valid. In such cases, remove the signal connector so that no signal is received, set the SYNC ON G to invalid, and reconnect the signal.
WHISPER	<p>Operation Start/Stop: Press the ◀ / ▶ button.</p> <p>Set/Clear Wisper Mode: Press ▲ / ▼ button. When the WHISPER is selected, the WHISPER mode is active. In the WHISPER mode, acoustic noise level from the unit is reduced, brightness level on screen is a little lower.</p>

MAINTENANCE

Lamp



**HIGH VOLTAGE
HIGH TEMPERATURE
HIGH PRESSURE**

Contact your dealer before replacing the lamp.

For the optional lamp, see the item “Optional Parts” of the Table 12.

Before replacing the lamp, switch power OFF, remove the power cord from the power outlet, and wait approximately 45 minutes until the lamp has cooled. The lamp may explode if handled at high temperatures.



WARNING • For disposal of used lamp, treat according to the instruction of community authorities.

- Since the lamp is made of glass, do not apply shock to it and do not scratch it.
- Also, do not use old lamp. This could also cause explosion of the lamp.
- If it is probable that the lamp has exploded (explosive sound is heard), disconnect the power plug from the power outlet and ask your dealer to replace lamp. The lamp is covered by front glass, but in rare cases, the reflector and the inside of the projector may be damaged by scattered broken pieces of glass, and broken pieces could cause injury when being handled.
- Do not use the projector with the lamp cover removed.

Lamp

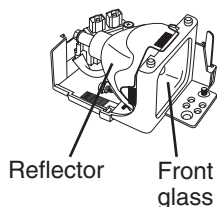

Lamp Life

Projector lamps have a finite life. The image will become darker, and hues will become weaker, after a lamp has been used for a long period of time.

Replace the lamp if the LAMP indicator is red, or the CHANGE THE LAMP message appears when the projector is switched ON. See Table 9 of P.19 and Table 10 of P.20.

NOTE • The LAMP indicator is also red when the lamp unit reaches high temperature. Before replacing the lamp, switch power OFF, wait approximately 20 minutes, and switch power ON again. If the LAMP indicator is still red, replace the lamp.

MAINTENANCE (continued)

Replacing the Lamp

1. Switch the projector OFF, remove the power cord from the power outlet, and wait at least 45 minutes for the unit to cool.
2. Prepare a new lamp.
3. Check that the projector has cooled sufficiently, and gently turn it upside down.
4. Loosen the two screws as shown in the diagram, and remove the lamp cover.
5. Loosen the one screw, and gently remove the lamp while holding the grips. Touching the inside of the lamp case may result in uneven coloring.
6. Install the new lamp and tighten the one screw firmly. Also steadily push the opposite side of the screwed lamp into the unit.
7. Replace the lamp cover in position and tighten the two screws firmly.
8. Gently turn the projector right-side up.

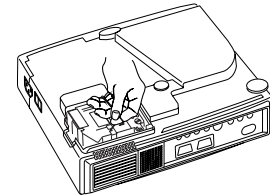
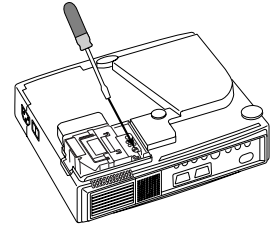
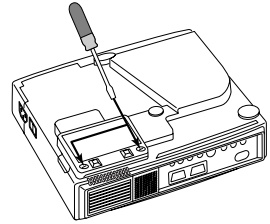

CAUTION • Ensure that screws are tightened properly. Screws not tightened fully may result in injury or accidents.
• Do not use the projector with the lamp cover removed.

Resetting the Lamp Timer

Reset the lamp timer after replacing the lamp. When the message of “CHANGE THE LAMP ... THE POWER WILL TURN OFF AFTER 0 hr.” is displayed, complete the following operation within 10 minutes. The power will be turned off automatically in over 10 minutes.

1. Switch power ON, and press the RESET button, for approximately three seconds. The ‘LAMP xxxx hr’ message will appear on the lamp timer on the bottom of the screen.
2. Press the MENU button on the remote control transmitter, or the RESET button on the control panel, while the lamp timer is displayed. The ‘LAMP xxxx □ → 0 ■ CANCEL’ message will then appear.
3. Press the  and select 0, and wait until the timer display is cleared.

NOTE • Do not reset the lamp timer without replacing the lamp. Reset the lamp timer always when replacing the lamp. The message functions will not operate properly if the lamp timer is not reset correctly.

MAINTENANCE (continued)

Air Filter Maintenance

The air filter should be cleaned as described below at intervals of approximately 100 hours.

1. Switch the projector power supply OFF, and remove the power cord from the power outlet.
2. Clean the air filter with a vacuum cleaner.



CAUTION • Switch power OFF and remove the power cord from the power outlet before beginning maintenance work. Please read the separate “SAFETY INSTRUCTIONS” thoroughly to ensure that maintenance is performed correctly.

- Replace the air filter if contamination cannot be removed, or if it is damaged. Contact your dealer in such case. For the optional air filter, see the item “Optional Parts” of the Table 12.
- Do not use the equipment with the air filter removed.
- When the air filter is clogged with dust etc. the power supply is switched OFF automatically to prevent the temperature rising inside the projector.

Other Maintenance

Maintenance Inside the Equipment

For safety reasons, ensure that the equipment is cleaned and checked by the dealer once every two years. Maintaining the equipment by yourself is dangerous.

Cleaning the Lens

Gently wipe the lens with lens cleaning paper. Do not touch the lens with your hands.

Cleaning the Cabinet and Remote control transmitter

Gently wipe with a soft cloth. If dirt and stains etc. are not easily removed, use a soft cloth dampened with water, or water and a neutral detergent, and wipe dry with a soft, dry cloth.



CAUTION • Switch power OFF and remove the power cord from the power outlet before beginning maintenance work. Please read the separate “SAFETY INSTRUCTIONS” thoroughly to ensure that maintenance is performed correctly.

- Do not use detergents or chemicals other than those noted above (e.g. benzene or thinners).
- Do not use cleaning sprays.
- Do not rub with hard materials, or tap the equipment.

TROUBLESHOOTING

OSD Message

The messages as described below may appear on the screen at power ON. Take the appropriate measures when such messages appears.

Table 9. OSD Messages

Message	Contents
CHANGE THE LAMP AFTER REPLACING LAMP, RESET THE LAMP TIME. (*1)	The usage time of lamp will be reaching 2000 hr shortly.(*2) It is recommended to replace the lamp soon. Prepare a new lamp as a replacement.
CHANGE THE LAMP AFTER REPLACING LAMP, RESET THE LAMP TIME. THE POWER WILL TURN OFF AFTER ** hr. (*1)	The usage time of lamp will be reaching 2000 hr shortly. It is recommended to replace the lamp within * * hours.(*2) It might be happened that the lamp is cut off before * * hr by any chance. Power will be switched OFF automatically in * * hours. Replace the lamp as shown in P.17~18 "Lamp". Always reset the lamp timer after replacing the lamp.
CHANGE THE LAMP AFTER REPLACING LAMP, RESET THE LAMP TIME. THE POWER WILL TURN OFF AFTER 0 hr.	The usage time of lamp is about to reach. Power will be switched OFF in a few minutes.(*2) Switch power OFF immediately and replace the lamp as shown in P.17 ~18 "Lamp". Always reset the lamp timer after replacing the lamp.
NO INPUT IS DETECTED ON ***	No input signal found. Check signal input connections and signal sources.
SYNC IS OUT OF RANGE ON ***	The horizontal or vertical frequency of the input signal is not within the specified range. Check the specifications of the equipment and the signal source.

NOTE (*1) This message is cleared automatically after approximately three minutes, and appears every time power is switched ON.

(*2) The unit has a function to turn the power off which will be active when the usage time reaches 2000 hr. However the life of lamp might be much different among lamps, so that it might be happened that a lamp is cut off before the function is active.

TROUBLESHOOTING (continued)

Indicators Message

The POWER indicator, LAMP indicator, and TEMP indicator are lit and blank as follows. Take the appropriate measures.

Table 10. Indicators Message

POWER indicator	LAMP indicator	TEMP indicator	Contents
Lights orange	Turns off	Turns off	The Standby mode has been set.
Blinks green	Turns off	Turns off	Warming up. Please wait.
Lights green	Turns off	Turns off	ON. Normal operation possible.
Blinks orange	Turns off	Turns off	Cooling. Please wait.
Blinks red	-	-	Cooling. Please wait. The error is found. Take the appropriate measures when the POWER indicator ceases blinking
Blinks /Lights red	Lights red	Turns off	Lamp is not lit. The interior of the equipment may be too hot. Switch power OFF, wait 20 minutes until the equipment cools, and check whether the ventilation openings are blocked, whether the air filter is dirty, or whether the ambient temperature exceeds 35 °C. And switch power ON again. Replace the lamp if the same problem occurs.
Blinks /Lights red	Blinks red	Turns off	Lamp or lamp cover is not found, or hasn't been fitted in correctly. Switch power OFF, and wait for 45 minutes until the equipment cools. Check fitting of the lamp and lamp cover, and switch power ON again. Contact your dealer if the same problem occurs again.
Blinks /Lights red	Turns off	Blinks red	The cooling fan is not operating. Switch power OFF, and wait for 20 minutes until the equipment cools. Check for foreign matters in the fan, and switch power ON again. Contact your dealer if the same problem occurs again.
Blinks /Lights red	Turns off	Lights red	The interior of the equipment is too hot. *2) Switch power OFF, and wait for 20 minutes until the equipment cools. Check whether the ventilation openings are blocked, whether the air filter is dirty, or whether the ambient temperature exceeds 35 °C. Then switch power ON again. Contact your dealer if the same problem occurs again.
Lights green	Blinks red	Blinks red	The interior of the equipment is too cool. Check whether the ambient temperature is below 0°C. Contact your dealer if the same problem occurs when the ambient temperature is 0~35°C.

NOTE *2) When the internal temperature becomes excessive power is switched OFF automatically for safety reasons, and the indicator is extinguished. Set the power switch to [O] and wait for 20 minutes until the equipment has cooled sufficiently.

TROUBLESHOOTING (continued)

Symptom

Before requesting repair, check in accordance with the following chart. If the situation cannot be corrected, then contact your dealer.

Table 11. Symptom

Symptom	Possible cause	Remedy	Page
The power is not turned on.	The main power switch is not turned on.	Turn on the main power switch.	7,8
	The power cord is disconnected.	Plug the power cord into an AC power outlet.	
No video or audio.	The input is not correctly set.	Use the projector or remote control transmitter to set.	9
	No signal input.	Connect correctly.	6,7
Video is present but no audio.	The projector is not correctly connected.	Connect correctly.	6,7
	The volume is set to minimum.	Press VOLUME \ominus on the remote control or display the menu screen and adjust the volume.	10,14
	Mute is turned on.	Press the MUTE Ⓜ button.	10
Audio is present but no video.	The projector is not correctly connected.	Connect correctly.	6,7
	The brightness is set to minimum.	Select BRIGHT with the MENU button and the press the \ominus button.	11
	The slide lens door is still closed.	Open the slide lens door.	8
Colors are pale and color matching is poor.	Color density and color matching are not correctly adjusted.	Adjust the video.	11
Images are dark.	Brightness and contrast are not correctly adjusted.	Adjust the video.	11
	The lamp is nearing the end of its service life.	Replace with a new lamp.	16,17
Images are blurred.	Focus or H PHASE is out of adjustment.	Adjust the focus or H PHASE.	8,11

SPECIFICATIONS

Table 12. Specifications

Item		Specification	
Product name		Liquid crystal projector	
Liquid crystal panel	Panel size	1.8 cm (0.7 type)	
	Drive system	TFT active matrix	
	Pixels	CP-S225W : 480,000 pixels (800 horizontal x 600 vertical) CP-X275W : 786,432 pixels (1024 horizontal x 768 vertical)	
Lens		Zoom lens F=2.0 ~ 2.3 f=18 ~ 21 mm	
Lamp		150 W UHB	
Speaker		1.0 W	
Power supply		AC100 ~ 120V, 2.7A / AC220 ~ 240V, 1.3A	
Power consumption		240 W	
Temperature range		0 ~ 35°C (Operating)	
Size		289 (W) x 84 (H) x 215 (D) mm	
Weight (mass)		CP-S225W : 2.4 kg CP-X275W : 2.5 kg	
RGB signal input	RGB IN	Video: Analog 0.7Vp-p, 75Ω terminator (positive) H/V. sync.: TTL level (positive/negative) Composite sync.: TTL level D-sub 15-pin shrink jack	
	AUDIO IN	200mVrms, 47 kΩ (max. 3.0Vp-p) Stereo mini jack	
Video signal input	VIDEO	1.0Vp-p, 75Ω terminator RCA jack	
	S-VIDEO	Brightness signal: 1.0Vp-p, 75Ω terminator Color signal: 0.286Vp-p (NTSC, burst signal), 75Ω terminator 0.3Vp-p (PAL/SECAM, burst signal), 75Ω terminator Mini DIN 4-pin jack	
	COMPONENT VIDEO	Y	1.0 Vp-p, 75 Ω Terminator (Positive)
		CB/CR	0.7 Vp-p, 75 Ω Terminator (Positive)
		PB/PR	0.7 Vp-p, 75 Ω Terminator (Positive)
	AUDIO	L	200mVrms, 47 kΩ (max. 3.0Vp-p)
R		RCA jack	
Control functions	CONTROL	D-sub 15-pin shrink plug	
Optional Parts		Lamp: DT00401 (CP-S225W) / DT00461 (CP-X275W) Air Filter: MU01461 * For others, consult your dealer.	

NOTE • This specifications are subject to change without notice.

WARRANTY AND AFTER-SERVICE

If a problem occurs with the equipment, first refer to the P.20 “TROUBLESHOOTING” section and run through the suggested checks. If this does not resolve the problem contact your dealer or service company. They will tell you what warranty condition is applied.

TECHNICAL

Dimension Diagram

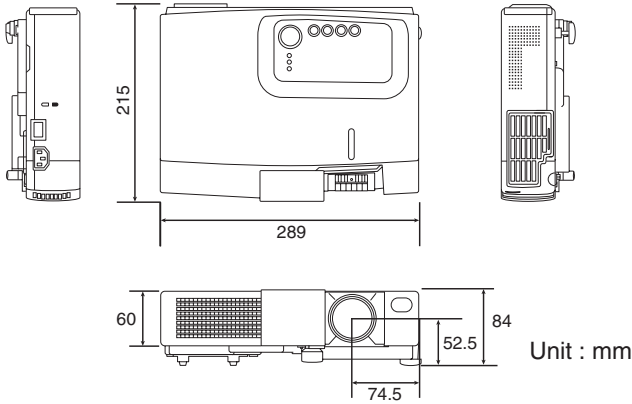

Signal Connector Pin Assignment

1. D-sub 15-pin Shrink Connector (RGB IN)

Pin No	Signal	Pin No	Signal
1	Video input Red	9	-
2	Video input Green	10	Ground
3	Video input Blue	11	-
4	-	12	SDA(DDC)
5	Ground	13	H. sync./ Composite sync.
6	Ground Red	14	Vertical sync
7	Ground Green	15	SCL(DDC)
8	Ground Blue		

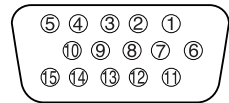

2. Mini Din 4-pin Connector (S-VIDEO)

Pin No	Signal
1	Color:0.286Vp-p (NTSC, burst signal),75Ω terminator 0.3Vp-p (PAL/SECAM, burst signal),75Ω terminator
2	Brightness:1.0Vp-p, 75Ω terminator
3	Ground
4	Ground

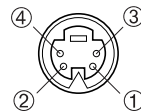

TECHNICAL (continued)

Example of computer signal

Resolution H × V	fH (kHz)	fV (Hz)	Rating	Signal mode	Display mode	
					CP-S225W	CP-X275W
720 × 400	37.9	85.0	VESA	TEXT	Zoom in	Zoom in
640 × 480	31.5	59.9	VESA	VGA (60Hz)	Zoom in	Zoom in
640 × 480	35.0	66.7		Mac13"mode	Zoom in	Zoom in
640 × 480	37.9	72.8	VESA	VGA (72Hz)	Zoom in	Zoom in
640 × 480	37.5	75.0	VESA	VGA (75Hz)	Zoom in	Zoom in
640 × 480	43.3	85.0	VESA	VGA (85Hz)	Zoom in	Zoom in
800 × 600	35.2	56.3	VESA	SVGA (56Hz)		Zoom in
800 × 600	37.9	60.3	VESA	SVGA (60Hz)		Zoom in
800 × 600	48.1	72.2	VESA	SVGA (72Hz)		Zoom in
800 × 600	46.9	75.0	VESA	SVGA (75Hz)		Zoom in
800 × 600	53.7	85.1	VESA	SVGA (85Hz)		Zoom in
832 × 624	49.7	74.5		Mac16"mode	Zoom out	Zoom in
1024 × 768	48.4	60.0	VESA	XGA (60Hz)	Zoom out	
1024 × 768	56.5	70.1	VESA	XGA (70Hz)	Zoom out	
1024 × 768	60.0	75.0	VESA	XGA (75Hz)	Zoom out	
1024 × 768	68.7	85.0	VESA	XGA (85Hz)	Zoom out	
1152 × 864	67.5	75.0	VESA	SXGA (75Hz)	Zoom out	Zoom out
1280 × 960	60.0	60.0	VESA	SXGA (60Hz)	Zoom out	Zoom out
1280 × 1024	64.0	60.0	VESA	SXGA (60Hz)	Zoom out	Zoom out

- NOTE** • Some computers may have multiple display screen modes. Use of some of these modes will not be possible with this projector.
- Be sure to check jack type, signal level, timing and resolution before connecting this projector to a computer.
 - Depending on the input signal, full-size display may not be possible in some cases. Refer to the number of display pixels above.
 - The image might be something wrong with computer by computer on the digital RGB mode. In this case, it is recommended to reduce the resolution and / or refresh rate.

TECHNICAL (continued)

Initial set signals

The following signals are used for the initial settings.

The signal timing of some computer models may be different. In such case, refer to adjust the V.POSIT and H.POSIT of the menu.

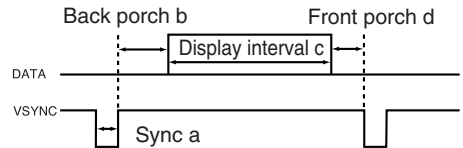
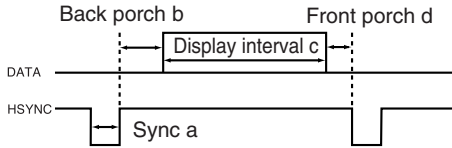

Computer / Signal	Horizontal signal timing (μs)			
	a	b	c	d
TEXT	2.0	3.0	20.3	1.0
VGA (60Hz)	3.8	1.9	25.4	0.6
Mac 13"mode	2.1	3.2	21.2	2.1
VGA (72Hz)	1.3	3.8	20.3	1.0
VGA (75Hz)	2.0	3.8	20.3	0.5
VGA (85Hz)	1.6	2.2	17.8	1.6
SVGA (56Hz)	2.0	3.6	22.2	0.7
SVGA (60Hz)	3.2	2.2	20.0	1.0
SVGA (72Hz)	2.4	1.3	16.0	1.1
SVGA (75Hz)	1.6	3.2	16.2	0.3
SVGA (85Hz)	1.1	2.7	14.2	0.6
Mac 16"mode	1.1	3.9	14.5	0.6
XGA (60Hz)	2.1	2.5	15.8	0.4
XGA (70Hz)	1.8	1.9	13.7	0.3
XGA (75Hz)	1.2	2.2	13.0	0.2
XGA (85Hz)	1.0	2.2	10.8	0.5
1152x864 (75Hz)	1.2	2.4	10.7	0.6
1280x960 (60Hz)	1.0	2.9	11.9	0.9
1280x1024 (60Hz)	1.0	2.3	11.9	0.4

Computer / Signal	Vertical signal timing (lines)			
	a	b	c	d
TEXT	3	42	400	1
VGA (60Hz)	2	33	480	10
Mac 13"mode	3	39	480	3
VGA (72Hz)	3	28	480	9
VGA (75Hz)	3	16	480	1
VGA (85Hz)	3	25	480	1
SVGA (56Hz)	2	22	600	1
SVGA (60Hz)	4	23	600	1
SVGA (72Hz)	6	23	600	37
SVGA (75Hz)	3	21	600	1
SVGA (85Hz)	3	27	600	1
Mac 16"mode	3	39	624	1
XGA (60Hz)	6	29	768	3
XGA (70Hz)	6	29	768	3
XGA (75Hz)	3	28	768	1
XGA (85Hz)	3	36	768	1
1152x864 (75Hz)	3	32	864	1
1280x960 (60Hz)	3	36	960	1
1280x1024 (60Hz)	3	38	1024	1

TECHNICAL (continued)

Connection to the Mouse Control

This function needs the optional "RMU Accessory kit".

If you need, ask your dealer.

For how to use the kit, please read the manual of the kit.

NOTE • Before connecting, read the instruction manuals of the devices to be connected.

- In the case of notebook type computers with an internal pointing device, the mouse control function will not work unless the internal pointing device is disabled. In such case, disable the internal pointing device and change the BIOS setting to select an external mouse.

Also, some computers may not have a utility program to operate a mouse.
Refer to the computer hardware manual for detail.

TECHNICAL (continued)

RS-232C communication

- (1) Turn off the projector and computer power supplies and connect with the RS-232C cable.
- (2) Turn on the computer power supply and after the computer has started up, turn on the projector power supply.

Control jack
D-sub 15-pin shrink jack

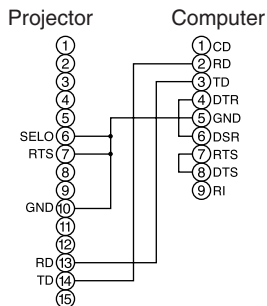
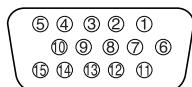

RS-232C jack
D-sub 9-pin



Communications setting

19200bps, 8N1

1 Protocol

Consist of header (7 bytes) + command data (6 bytes).

2 Header

BE + EF + 03 + 06 + 00 + CRC_low + CRC_high
 CRC_low : Lower byte of CRC flag for command data.
 CRC_high : Upper byte of CRC flag for command data.

3 Command data

Command data chart

byte_0	byte_1	byte_2	byte_3	byte_4	byte_5
Action		Type		Setting code	
low	high	low	high	low	high

Action (byte_0 - 1)

Action	Classification	Content
1	SET	Change setting to desired value.
2	GET	Read projector internal setup value.
4	INCREMENT	Increment setup value by 1.
5	DECREMENT	Decrement setup value by 1.
6	EXECUTE	Run a command.

TECHNICAL (continued)

Requesting projector status (Get command)

- (1) Send the request code Header + Command data ('02H'+ '00H' + type (2 bytes) + '00H'+ '00H') from the computer to the projector.
- (2) The projector returns the response code '1DH' + data (2 bytes) to the computer.

Changing the projector settings (Set command)

- (1) Send the setting code Header + Command data ('01H'+ '00H' + type (2 bytes) + setting code (2 bytes)) from the computer to the projector.
- (2) The projector changes the setting based on the above setting code.
- (3) The projector returns the response code '06H' to the computer.

Using the projector default settings (Reset Command)

- (1) The computer sends the default setting code Header + Command data ('06H'+ '00H' + type (2 bytes) + '00H'+ '00H') to the projector.
- (2) The projector changes the specified setting to the default value.
- (3) The projector returns the response code '06H' to the computer.

Increasing the projector setting value (Increment command)

- (1) The computer sends the increment code Header + Command data ('04H'+ '00H' + type (2 bytes) + '00H'+ '00H') to the projector.
- (2) The projector increases the setting value on the above setting code.
- (3) The projector returns the response code '06H' to the computer.

Decreasing the projector setting value (Decrement command)

- (1) The computer sends the decrement code Header + Command data ('05H'+ '00H' + type (2 bytes) + '00H'+ '00H') to the projector.
- (2) The projector decreases the setting value on the above setting code.
- (3) The projector returns the response code '06H' to the computer.

When a command sent by the projector cannot be understood by the computer

When the command sent by the projector cannot be understood, the error command '15H' is returned by the computer. Some times, the projector ignores RS-232C commands during other works. If the error command '15H' is returned, please send the same command again.

When data sent by the projector cannot be practice

When the command sent by the projector cannot be practiced, the the error code '1cH' + 'xxxxH' is returned.

When the data length is greater than indicated by the data length code, the projector will ignore the excess data code.

Conversely, when the data length is shorter than indicated by the data length code, an error code will be returned to the projector.

NOTE • Operation cannot be guaranteed when the projector receives an undefined command or data.

- Provide an interval of at least 40ms between the response code and any other code.
- The projector outputs test data when the power supply is switched ON, and when the lamp is lit. Ignore this data.
- Commands are not accepted during warm-up.

TECHNICAL (continued)

Command data chart

Names	Operation type		Header				Command data				
						CRC	Action	Type	Setting code		
Blank Color	Set	Red	BE	EF	03	06	00	3B D3	01 00	00 30	00 00
		Orange	BE	EF	03	06	00	AB D2	01 00	00 30	01 00
		Green	BE	EF	03	06	00	5B D2	01 00	00 30	02 00
		Blue	BE	EF	03	06	00	CB D3	01 00	00 30	03 00
		Purple	BE	EF	03	06	00	FB D1	01 00	00 30	04 00
		White	BE	EF	03	06	00	6B D0	01 00	00 30	05 00
		Black	BE	EF	03	06	00	9B D0	01 00	00 30	06 00
	Get	BE	EF	03	06	00	08 D3	02 00	00 30	00 00	
Mirror	Set	Normal	BE	EF	03	06	00	C7 D2	01 00	01 30	00 00
		H Inverse	BE	EF	03	06	00	57 D3	01 00	01 30	01 00
		V Inverse	BE	EF	03	06	00	A7 D3	01 00	01 30	02 00
		H&V Inverse	BE	EF	03	06	00	37 D2	01 00	01 30	03 00
	Get	BE	EF	03	06	00	F4 D2	02 00	01 30	00 00	
Freeze	Set	Normal	BE	EF	03	06	00	83 D2	01 00	02 30	00 00
		Freeze	BE	EF	03	06	00	13 D3	01 00	02 30	01 00
	Get	BE	EF	03	06	00	B0 D2	02 00	02 30	00 00	
Menu Color	Set	Red	BE	EF	03	06	00	7F D3	01 00	03 30	00 00
		Orange	BE	EF	03	06	00	EF D2	01 00	03 30	01 00
		Green	BE	EF	03	06	00	1F D2	01 00	03 30	02 00
		Blub	BE	EF	03	06	00	8F D3	01 00	03 30	03 00
		Purple	BE	EF	03	06	00	BF D1	01 00	03 30	04 00
		Transparent	BE	EF	03	06	00	2F D0	01 00	03 30	05 00
		Gray	BE	EF	03	06	00	DF D0	01 00	03 30	06 00
	Get	BE	EF	03	06	00	4C D3	02 00	03 30	00 00	
Startup	Set	Turn ON	BE	EF	03	06	00	0B D2	01 00	04 30	00 00
		Turn OFF	BE	EF	03	06	00	9B D3	01 00	04 30	01 00
	Get	BE	EF	03	06	00	38 D2	02 00	04 30	00 00	
Language	Set	English	BE	EF	03	06	00	F7 D3	01 00	05 30	00 00
		Français	BE	EF	03	06	00	67 D2	01 00	05 30	01 00
		Deutsch	BE	EF	03	06	00	97 D2	01 00	05 30	02 00
		Español	BE	EF	03	06	00	07 D3	01 00	05 30	03 00
		Italiano	BE	EF	03	06	00	37 D1	01 00	05 30	04 00
		Norsk	BE	EF	03	06	00	A7 D0	01 00	05 30	05 00
		Nederlands	BE	EF	03	06	00	57 D0	01 00	05 30	06 00
		Português	BE	EF	03	06	00	C7 D1	01 00	05 30	07 00
		Japanese	BE	EF	03	06	00	37 D4	01 00	05 30	08 00
	Get	BE	EF	03	06	00	C4 D3	02 00	05 30	00 00	

TECHNICAL (continued)

Command data chart

Names	Operation type	Header				Command data		
					CRC	Action	Type	Setting code
Magnify	Get	BE EF	03 06 00	7C D2	02 00	07 30	00 00	
	Increment	BE EF	03 06 00	1A D2	04 00	07 30	00 00	
	Decrement	BE EF	03 06 00	CB D3	05 00	07 30	00 00	
Auto off	Get	BE EF	03 06 00	08 86	02 00	10 31	00 00	
	Increment	BE EF	03 06 00	6E 86	04 00	10 31	00 00	
	Decrement	BE EF	03 06 00	BF 87	05 00	10 31	00 00	
Brightness Reset	Execute	BE EF	03 06 00	58 D3	06 00	00 70	00 00	
Contrast Reset	Execute	BE EF	03 06 00	A4 D2	06 00	01 70	00 00	
V.Position Reset	Execute	BE EF	03 06 00	E0 D2	06 00	02 70	00 00	
H.Position Reset	Execute	BE EF	03 06 00	IC D3	06 00	03 70	00 00	
H.Size Reset	Execute	BE EF	03 06 00	68 D2	06 00	04 70	00 00	
Color Balance R Reset	Execute	BE EF	03 06 00	94 D3	06 00	05 70	00 00	
Color Balance B Reset	Execute	BE EF	03 06 00	D0 D3	06 00	06 70	00 00	
Sharpness Reset	Execute	BE EF	03 06 00	C4 D0	06 00	09 70	00 00	
Color Reset	Execute	BE EF	03 06 00	80 D0	06 00	0A 70	00 00	
Tint Reset	Execute	BE EF	03 06 00	7C D1	06 00	0B 70	00 00	
Keystone_V Reset	Execute	BE EF	03 06 00	08 D0	06 00	0C 70	00 00	
Auto	Execute	BE EF	03 06 00	91 D0	06 00	0A 20	00 00	
Blank on/off	Set	off	BE EF	03 06 00	FB D8	01 00	20 30	00 00
		on	BE EF	03 06 00	6B D9	01 00	20 30	01 00
	Get	BE EF	03 06 00	C8 D8	02 00	20 30	00 00	
Error Status	Get		BE EF	03 06 00	D9 D8	02 00	20 60	00 00
		(Example of Return)	00 00	01 00	02 00	03 00	(Normal)	(Cover-error)
			04 00	05 00	06 00	(reserved)	(reserved)	(Lamp-Time-over)
Power	Set	OFF	BE EF	03 06 00	2A D3	01 00	00 60	00 00
		ON	BE EF	03 06 00	BA D2	01 00	00 60	01 00
	Get	BE EF	03 06 00	19 D3	02 00	00 60	00 00	
Input Source	Set	RGB1	BE EF	03 06 00	FE D2	01 00	00 20	00 00
		Video	BE EF	03 06 00	6E D3	01 00	00 20	01 00
		SVideo	BE EF	03 06 00	9E D3	01 00	00 20	02 00
		Component	BE EF	03 06 00	AE D1	01 00	00 20	05 00
	Get	BE EF	03 06 00	CD D2	02 00	00 20	00 00	
Volume	Get	BE EF	03 06 00	31 D3	02 00	01 20	00 00	
	Increment	BE EF	03 06 00	57 D3	04 00	01 20	00 00	
	Decrement	BE EF	03 06 00	86 D2	05 00	01 20	00 00	

TECHNICAL (continued)

Command data chart

Names	Operation type		Header				Command data								
						CRC	Action	Type	Setting code						
Mute	Set	Normal	BE	EF	03	06	00	46	D3	01	00	02	20	00	00
		Mute	BE	EF	03	06	00	D6	D2	01	00	02	20	01	00
	Get	BE	EF	03	06	00	75	D3	02	00	02	20	00	00	
Brightness	Get		BE	EF	03	06	00	89	D2	02	00	03	20	00	00
	Increment		BE	EF	03	06	00	EF	D2	04	00	03	20	00	00
	Decrement		BE	EF	03	06	00	3E	D3	05	00	03	20	00	00
Contrast	Get		BE	EF	03	06	00	FD	D3	02	00	04	20	00	00
	Increment		BE	EF	03	06	00	9B	D3	04	00	04	20	00	00
	Decrement		BE	EF	03	06	00	4A	D2	05	00	04	20	00	00
Color Balance R	Get		BE	EF	03	06	00	01	D2	02	00	05	20	00	00
	Increment		BE	EF	03	06	00	67	D2	04	00	05	20	00	00
	Decrement		BE	EF	03	06	00	B6	D3	05	00	05	20	00	00
Color Balance B	Get		BE	EF	03	06	00	45	D2	02	00	06	20	00	00
	Increment		BE	EF	03	06	00	23	D2	04	00	06	20	00	00
	Decrement		BE	EF	03	06	00	F2	D3	05	00	06	20	00	00
Keystone_V	Get		BE	EF	03	06	00	B9	D3	02	00	07	20	00	00
	Increment		BE	EF	03	06	00	DF	D3	04	00	07	20	00	00
	Decrement		BE	EF	03	06	00	0E	D2	05	00	07	20	00	00
Aspect	Set	4:3, Full	BE	EF	03	06	00	9E	D0	01	00	08	20	00	00
		16:9	BE	EF	03	06	00	0E	D1	01	00	08	20	01	00
		Small	BE	EF	03	06	00	FE	D1	01	00	08	20	02	00
	Get	BE	EF	03	06	00	AD	D0	02	00	08	20	00	00	
Display Position at 16 : 9 or Small	Set	Default	BE	EF	03	06	00	62	D1	01	00	09	20	00	00
		Bottom	BE	EF	03	06	00	F2	D0	01	00	09	20	01	00
		Top	BE	EF	03	06	00	02	D0	01	00	09	20	02	00
	Get	BE	EF	03	06	00	51	D1	02	00	09	20	00	00	
V.Position	Get		BE	EF	03	06	00	0D	83	02	00	00	21	00	00
	Increment		BE	EF	03	06	00	6B	83	04	00	00	21	00	00
	Decrement		BE	EF	03	06	00	BA	82	05	00	00	21	00	00
H.Position	Get		BE	EF	03	06	00	F1	82	02	00	01	21	00	00
	Increment		BE	EF	03	06	00	97	82	04	00	01	21	00	00
	Decrement		BE	EF	03	06	00	46	83	05	00	01	21	00	00
H.Size	Get		BE	EF	03	06	00	B5	82	02	00	02	21	00	00
	Increment		BE	EF	03	06	00	D3	82	04	00	02	21	00	00
	Decrement		BE	EF	03	06	00	02	83	05	00	02	21	00	00
H.Phase	Get		BE	EF	03	06	00	49	83	02	00	03	21	00	00
	Increment		BE	EF	03	06	00	2F	83	04	00	03	21	00	00
	Decrement		BE	EF	03	06	00	FE	82	05	00	03	21	00	00
Sharpness	Get		BE	EF	03	06	00	F1	72	02	00	01	22	00	00
	Increment		BE	EF	03	06	00	97	72	04	00	01	22	00	00
	Decrement		BE	EF	03	06	00	46	73	05	00	01	22	00	00

TECHNICAL (continued)

Command data chart

Names	Operation type	Header				Command data			
					CRC	Action	Type	Setting code	
Color	Get	BE EF	03 06 00	B5 72	02 00	02 22	00 00		
	Increment	BE EF	03 06 00	D3 72	04 00	02 22	00 00		
	Decrement	BE EF	03 06 00	02 73	05 00	02 22	00 00		
Tint	Get	BE EF	03 06 00	49 73	02 00	03 22	00 00		
	Increment	BE EF	03 06 00	2F 73	04 00	03 22	00 00		
	Decrement	BE EF	03 06 00	FE 72	05 00	03 22	00 00		
Video Format	Set	Auto	BE EF	03 06 00	9E 75	01 00	00 22	0A 00	
		NTSC	BE EF	03 06 00	FE 71	01 00	00 22	04 00	
		PAL	BE EF	03 06 00	6E 70	01 00	00 22	05 00	
		SECAM	BE EF	03 06 00	6E 75	01 00	00 22	09 00	
		NTSC 4.43	BE EF	03 06 00	5E 72	01 00	00 22	02 00	
		M-PAL	BE EF	03 06 00	FE 74	01 00	00 22	08 00	
	N-PAL	BE EF	03 06 00	0E 71	01 00	00 22	07 00		
	Get	BE EF	03 06 00	0D 73	02 00	00 22	00 00		
HDTV	Set	1080i	BE EF	03 06 00	F2 73	01 00	05 22	00 00	
		1035i	BE EF	03 06 00	62 72	01 00	05 22	01 00	
	Get	BE EF	03 06 00	C1 73	02 00	05 22	00 00		
Sync on G	Set	off	BE EF	03 06 00	CB D0	01 00	08 30	01 00	
		on	BE EF	03 06 00	5B D1	01 00	08 30	00 00	
	Get	BE EF	03 06 00	68 D1	02 00	08 30	00 00		
WHISPER	Set	NORMAL	BE EF	03 06 00	3B 23	01 00	00 33	00 00	
		WHISPER	BE EF	03 06 00	AB 22	01 00	00 33	01 00	
	Get	BE EF	03 06 00	08 23	02 00	00 33	00 00		
GAMMA	Set	NORMAL	BE EF	03 06 00	C7 F0	01 00	A1 30	00 00	
		CINEMA	BE EF	03 06 00	57 F1	01 00	A1 30	01 00	
		DYNAMIC	BE EF	03 06 00	A7 F1	01 00	A1 30	02 00	
	Get	BE EF	03 06 00	F4 F0	02 00	A1 30	00 00		
COLOR TEMP.	Set	NORMAL	BE EF	03 06 00	FB F5	01 00	B0 30	00 00	
		LOW	BE EF	03 06 00	6B F4	01 00	B0 30	01 00	
	Get	BE EF	03 06 00	C8 F5	02 00	B0 30	00 00		

REGULATORY NOTICES

FCC Statement Warning

WARNING: This equipment has been tested and found to comply with the limits for a Class B digital device, pursuant to Part 15 of the FCC Rules. These limits are designed to provide reasonable protection against harmful interference in a residential installation. This equipment generates, uses, and can radiate radio frequency energy and, if not installed and used in accordance with the instructions, may cause harmful interference to radio communications. However, there is no guarantee that interference will not occur in a particular installation. If this equipment does cause harmful interference to radio or television reception, which can be determined by turning the equipment off and on, the user is encouraged to try to correct the interference by one or more of the following measures:

- Reorient or relocate the receiving antenna.
- Increase the separation between the equipment and receiver.
- Connect the equipment into an outlet on a circuit different from that to which the receiver is connected.
- Consult the dealer or an experienced radio/TV technician for help.

INSTRUCTIONS TO USERS: This equipment complies with the requirements of FCC (Federal Communication Commission) equipment provided that the following conditions are met.

The cables may have to be used with the core set to the projector side. Use the cables which are included with the projector or specified.

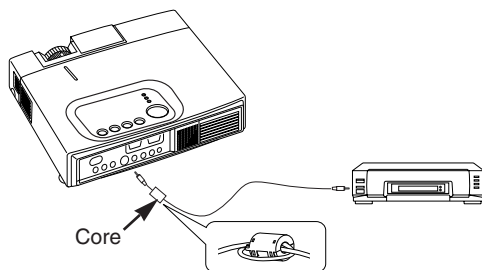

CAUTION: Changes or modifications not expressly approved by the party responsible for compliance could void the user's authority to operate the equipment.

For the Customers in CANADA

NOTICE: This Class B digital apparatus complies with Canadian ICES-003.

Pour les utilisateurs au Canada

AVIS: Cet appareil numérique de la Classe B est conforme à la norme NMB-003 du Canada.

HITACHI

Hitachi America, Ltd.

Computer Division 2000 Sierra Point Parkway,
MS760 Brisbane, CA 94005-1835
Tel: +1-800-225-1741 Fax: +1-650-244-7776
www.hitachi.com/lcd.

Hitachi Canada, Ltd.

6740 Campobello Road, Mississauga, Ontario
L5N2L8, Canada
Tel: +1-905-821-4545 Fax: +1-905-821-1101

Hitachi Home Electronics (Europe), Ltd.

Dukes Meadow, Millboard Road, Bourne End,
Buckinghamshire SL8 5XF UK
Tel: +44-162-864-3000 Fax: +44-162-864-3400

Hitachi Home Electronics Europe Ltd

426 Bergensesteenweg, 1500 Halle, Belgium
Tel: +32-2-363-9901 Fax: +34-2-363-9900

Hitachi Home Electronics Europe Ltd

Gewerbepark, Hintermattlistr, Postfach, 5506
Magenwil, Switzerland
Tel: +41-62-889-8011 Fax: +41-62-896-4771

Hitachi Europe GmbH

Business Systems Division
Via T. Gulli. 39, 20147 Milano, Italy
Tel: +39-2-487861 Fax: +39-2-48786322

Hitachi Sales Europe GmbH

Business Systems Division
Am Seestern 18, 40547 Dusseldorf, Germany
Tel: +49-211-529-1551 Fax: +49-211-529-1594

Hitachi Business Systems (Nordic)

Brugata 14, N-0184 Oslo, Norway
Tel: +47-2205-9060 Fax: +47-2205-9061

Hitachi Business Systems (Nordic)

Domnarvsgatan 29, Lunda, Box 62, S-163 91
Spanga, Sweden
Tel: +46-8-621-8260 Fax: +46-8-761-6250

Hitachi Business Systems (Nordic)

Kuldysen 13, DK-2630 Tåstrup, Denmark
Tel: +45-43-99-9200 Fax: +45-43-99-9392

Hitachi Business Systems (Nordic)

Tapiolan Keskustorni 11 Krs. Fin-02100 Espoo,
Finland
Tel: +358-9-3487-1188 Fax: +358-9-455-2152

Hitachi France

Immeuble, 'Ariane', 18 Rue Grange Dame Rose,
B.P. 134, 78148 Velizy, Cedex, France
Tel: +33-1-34630542 Fax: +33-1-34650761

Hitachi Sales Iberica S A

Gran Via Carlos 111, 101, 1-1, 08028 Barcelona,
Spain
Tel: +34-3-330-8652 Fax: +34-3-339-7839

Hitachi Home Electronics Asia, (S) Pte Ltd.

16 Collyer Quay #20-00 Hitachi Tower Singapore
049318, Singapore
Tel: +65-536-2520 Fax: +65-536-2521

Hitachi Sales (Malaysia) Sdn. Bhd.

Wisma Hitachi, No.2, Lorong 13/6A, 46200
Petaling
Jaya, Selangor Darul Ehsan, Malaysia
Tel: +60-3-7573455 Fax: +60-3-7556090

Hitachi Sales (Thailand), Ltd.

994,996 Soi Thonglor, Sukhumvit 55 Road,
Klongton,
Klongtoey, Bangkok 10110, Thailand
Tel: +66-2-381-8381 Fax: +66-2-381-9520

Hitachi (Hong Kong), Ltd.

8th Floor Park-in Commercial Centre, No.56,
Dundas
Street, Kowloon Bay, Kowloon, Hong Kong
Tel: +852-2-7804351 Fax: +852-2-7804915

Hitachi Sales Corp. of Taiwan.

2nd Floor, No.65, Nanking East Road, Section 3,
Taipei, Taiwan
Tel: +886-2-516-0500 Fax: +886-2-516-1501

Hitachi Australia Ltd.

13-15 Lyonpark Road, North Ryde NSW 2113,
Australia
Tel: +61-2-9888-4100 Fax: +61-2-9888-4144

Hitachi, Ltd.

15-12, Nishi Simbashi 2-chome, Minato-ku, Tokyo,
105 Japan
Tel: +81-3-3502-2111 Fax: +81-3-3506-1440



QR51381

Printed in Japan